



SIAT

M. J. MAILLIS GROUP

F44

F144-F344 range

Automatic Case Erectors

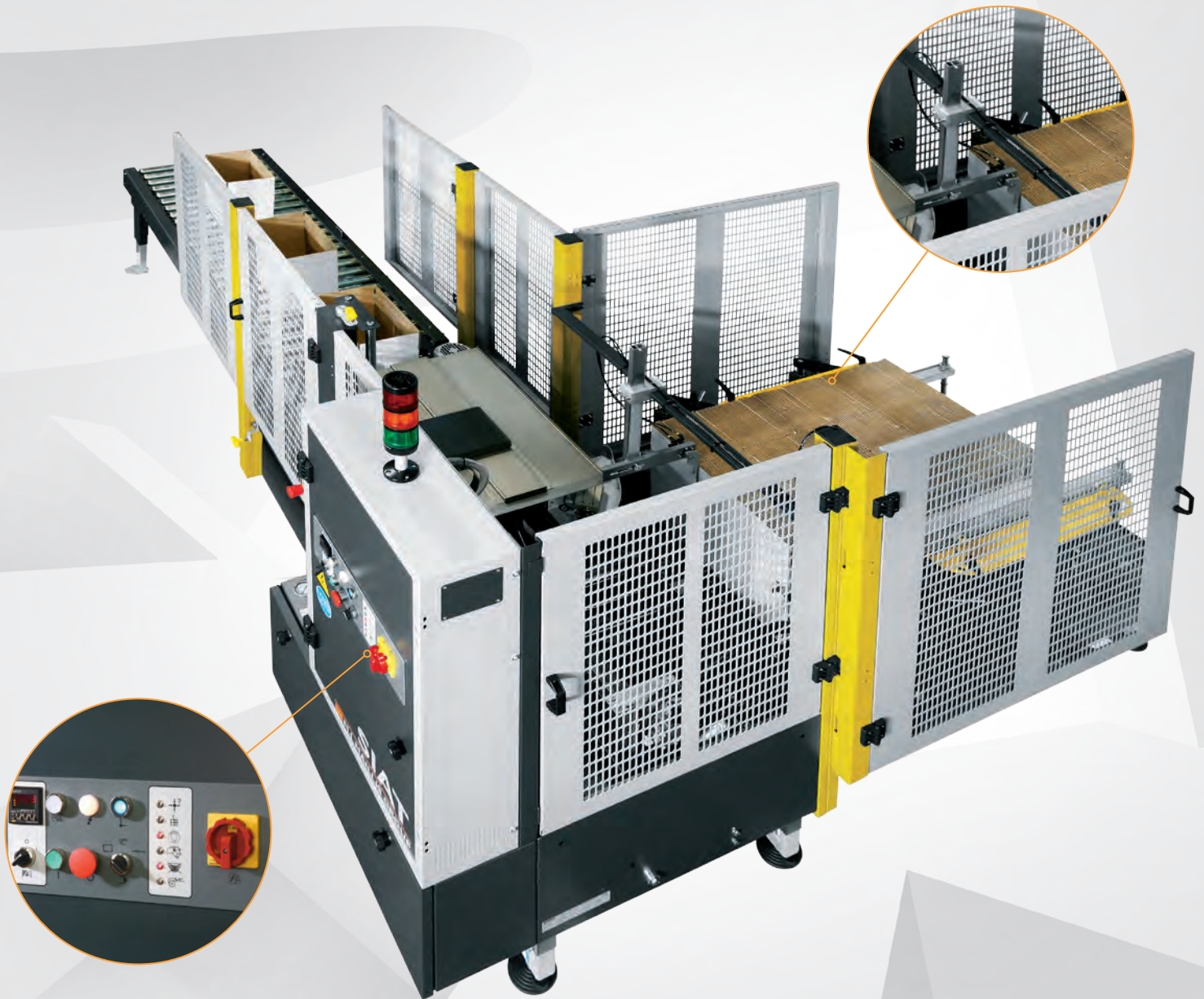

CE

F44

F44 is an automatic case erector with boxes storage in line. It is designed to fold and at a later stage to seal with adhesive tape the bottom of boxes. The machine runs at a variable output up to 480 boxes/hour according to box dimensions. Machine adjustments are simple and fast. F44 model has been designed in compliance with CE regulations.



Control panel

Polycarbonate safety panels

3-color-lighted indicator



Key Features

- Gravity box storage for 150 boxes
- Boxes storage in line
- Drive belts speed 21 m/min.
- Output up to 480 boxes/hour
- 1 arm activated by a pneumatic system with suction cups to take cartons from the boxes storage, to fold and to take them away by drive belts (2 x Motors kW 0,18 each) for the bottom flaps folding & sealing
- K11R taping unit - 50 mm width
- VENTURI® vacuum system
- Control panel equipped with: box counter - box timer, low box storage alarm, low tape/ no tape alarm, full line alarm after the machine
- Safety protections with switches to disconnect electric & pneumatic circuits if opened
- Machine controlled by PLC

SX - Left version

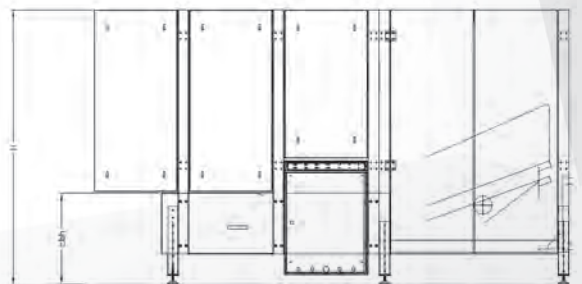
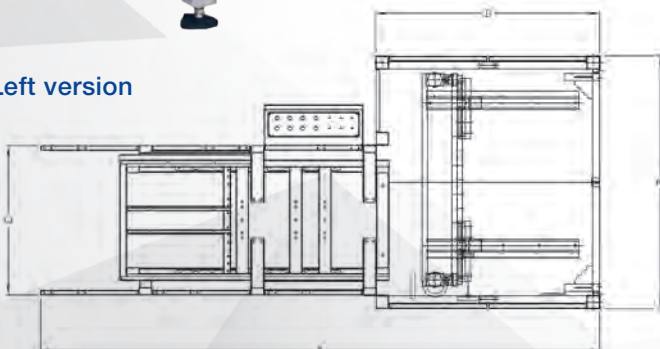

DX - Right version

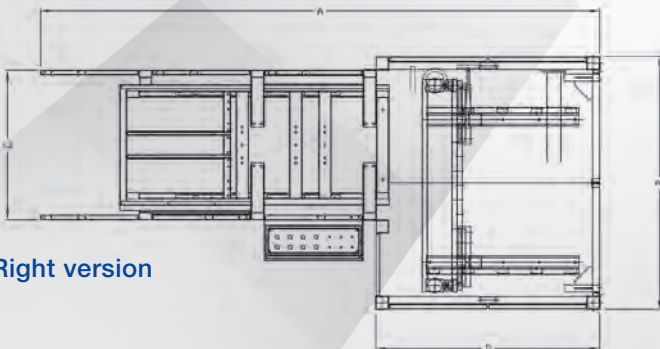

	F44
A	3113
B	1405
C	830
D	1246
H	1800 / 2150

for more details:



F144

F144 is an automatic case erector designed to fold and at a later stage to seal with adhesive tape the bottom of boxes. The machine runs at a variable output up to 700 boxes/hour according to box dimensions. Machine adjustments are simple and fast. F144 model has been designed in compliance with CE regulations.

Key Features

- Box storage for 150 boxes
- Box storage available on left side (SX) or right side (DX)
- Output up to 700 boxes/hour
- 2 carriages activated by a pneumatic system with suction cups to take cartons from the boxes storage, to fold and to take them away by drive belts (2 x Motors kW 0,18 each) for the bottom flaps forming & sealing
- K11R taping unit - 50 mm width
- VENTURI® vacuum system
- Control panel equipped with: box counter - box timer, low box storage alarm, low tape / no tape alarm, full line alarm after the machine
- Safety protections with switches to disconnect electric & pneumatic circuits if opened
- Machine controlled by PLC



Control panel with visual indicators of operation anomalies



Metal safety protections

3-color-lighted indicator

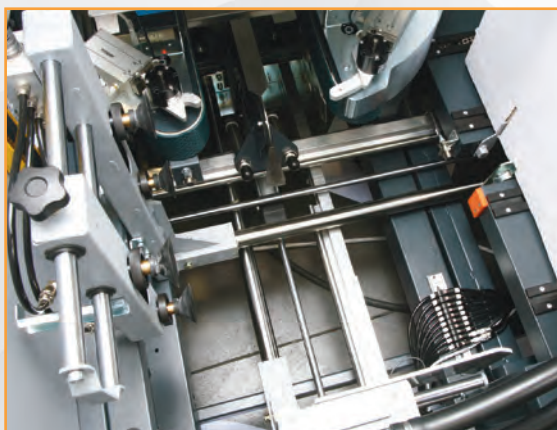

Pneumatic cylinders for box moving and box folding



F144 inox: automatic case erector made of stainless steel

for more details:



F344

F344 is an automatic case erector designed to form and at a later stage to seal with adhesive tape the bottom of boxes. The machine runs at a variable output up to 1100 boxes/hour according to box dimensions. Machine adjustments are simple and fast. F344 model has been designed in compliance with CE regulations.

Key Features

- Box storage for 150 boxes
- Box storage available on left side (SX) or right side (DX)
- Output up to 1100 boxes/hour
- 2 carriages activated by a pneumatic system with suction cups to take cartons from the boxes storage, to fold and to take them away by drive belts (2 x Motors kW 0,65 each) for the bottom flaps folding & sealing
- K11R taping unit - 50 mm width
- Vacuum pumps system
- Control panel equipped with: touchscreen panel with trouble shooting, automatic "0" setting, carriages speed adjustment, box counter - box timer, low box storage alarm, low tape / no tape alarm, full line alarm after the machine
- Safety protections with switches to disconnect electric & pneumatic circuits if opened
- Machine controlled by PLC



Touch screen control panel for machine functions management



3-color-lighted indicator

Polycarbonate safety panels (optional)



Standard/extended box storage



Vacuum pump for box picking

for more details: 

F144 / F344 left (SX) and right (DX) version



Standard box storage capacity: 80 ÷ 150 boxes according to thickness.

SX

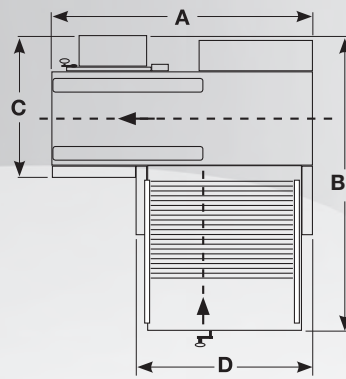

DX

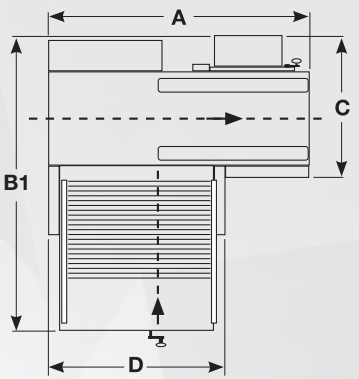

Extended box storage capacity: 160 ÷ 300 boxes according to thickness.

SX

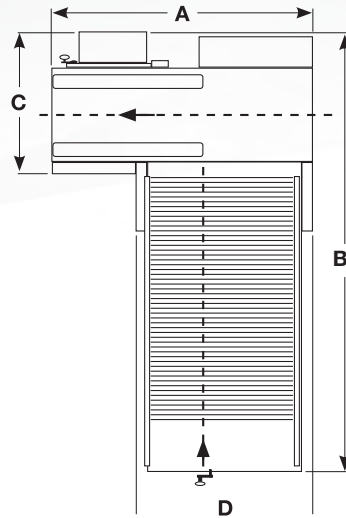

DX

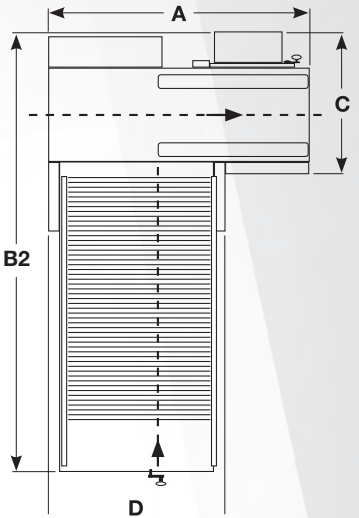

How to choose between a right hand and a left hand machine when using printed boxes

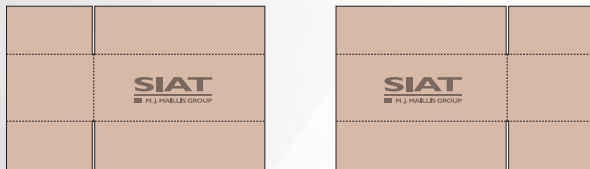

Modifications to be done on the squared boxes

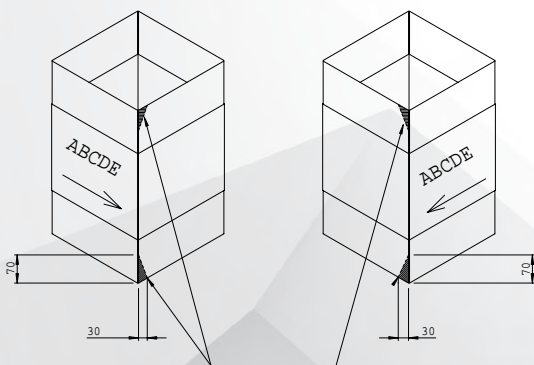

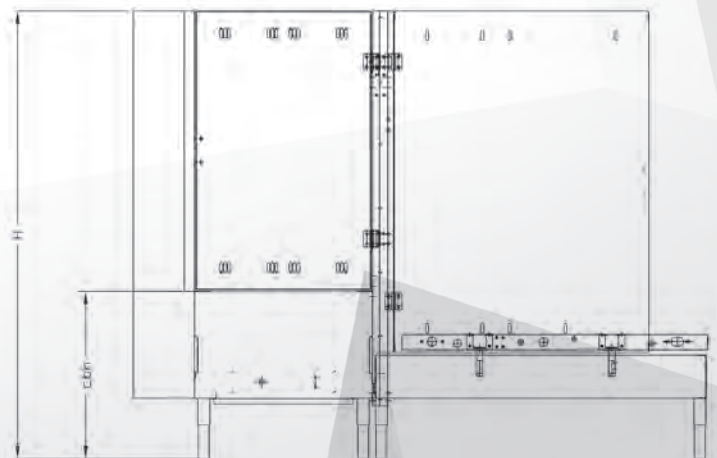

Overall machine dimensions with standard or optional extended box storage

	F144/4 F344/4	F144 F344	F145 F345	F146 F346
A	1720	1720	1840	1940
B1	2280	2280	2300	2370
B2	-	3280	3340	3370
C	1060	1060	1020	1050
D	1100	1100	1230	1320
H	1645 / 1800	1645 / 1800	1645 / 1800	1750 / 1950



> **Machine dimensions**
 Dimensioni macchina
 Machinmessungen
 Dimensions machine
 Dimensiones de máquina

Size / Weigth packaging			LxWxH 
> F44	550	850	290x150x220
> F144-F144/4 > F344-F344/4	600	850	255x210x220
> F145 - F345	600	850	255x210x220
> F146 - F346	650	850	255x240x220

> **F44**

	Min.	Max
H	1800	2150
cbh	600	950
AS 77	700	1050

> **F144-F344-F144/4-F344/4**

	Min.	Max
H	1645	1800
cbh	545	700
AS 109	665	820

> **F145 - F345**

	Min.	Max
H	1645	1800
cbh	545	700
AS 109	665	820

> **F146 - F346**

	Min.	Max
H	1750	1950
cbh	650	850
AS 109	770	970

> **Taping units**
 Unità nastranti
 Verschlusseinheiten
 Unités enrubanueuses
 Unidades de precinto

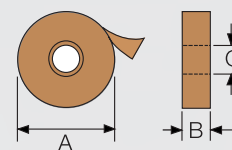

K11R/ K12R	
mm	
A	410 Max
B	50 / 75
C	76

> **Box dimensions**
 Dimensioni delle scatole
 Kartonabmessungen
 Dimensions des boîtes
 Dimensiones de cajas

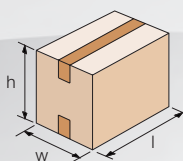

> **F44**

	K11R std. / K12R on demand	
	Min.	Max
l	200	450
w	150	350
h	150	450

> **F144 - F344**

	K11R std. / K12R on demand	
	Min.	Max
l	150	450
w	150	350
h	150	450

> **F144/4 - F344/4**

	K11R std. / K12R on demand	
	Min.	Max
l	150	450
w	130	350
h	120	400

> **F145-F345**

	K11R std. / K12R on demand	
	Min.	Max
l	200	560
w	150	350
h	150	450

> **F146-F346**

	K11R std. / K12R on demand	
	Min.	Max
l	300	620
w	200	400
h	220	450

> **Production capacity**
 Capacità di produzione
 Produktionskapazität
 Capacité de production
 Capacidad de producción

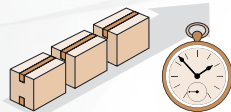

> F44	Bph
Max pcs.*	480

> F144 > F144/4	Bph
Max pcs.*	700

> F145	Bph
Max pcs.*	600

> F146	Bph
Max pcs.*	500

> F344 > F344/4	Bph
Max pcs.*	1100

> F345	Bph
Max pcs.*	1000

> F346	Bph
Max pcs.*	900

* Always based on shorter manageable box

> **Air consumption**
 Consumo aria
 Luftverbrauch
 Consommation d'air
 Consumo de aire

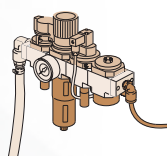

> F44	NL.
Cycle	48

> F144 > F144/4	NL.
Cycle	48

> F145 > F146	NL.
Cycle	54

> F344 > F344/4 > F345 > F346	NL.
Cycle	9

from 5,5 bar to 7 bar

> **Standard voltage**
 Voltaggio standard
 Standardspannung
 Tension standard
 Voltaje estándar

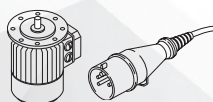

> **F44**

380/400V - 50Hz - 3F	
440V - 60Hz - 3F	
Amps	1,33
Power kW	0,36
Phase	3Ph + N + PE

> **F144 - F144/4 - F145 - F146**

380/400V - 50Hz - 3F	
440V - 60Hz - 3F	
Amps	1,33
Power kW	0,36
Phase	3Ph + PE

> **F344 - F344/4 - F345 - F346**

380/400V - 50Hz - 3F	
440V - 60Hz - 3F	
Amps	5,73
Power kW	1,31
Phase	3Ph + N + PE

> **Optionals**
 Accessori
 Zubehör
 Accessories
 Accesorios

> **AS77 (only for F44)**

Casters
 Set ruote
 Rädchen
 Roulettes
 Ruedas

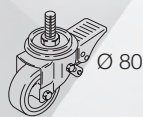

> **AS109**

Casters
 Set ruote
 Rädchen
 Roulettes
 Ruedas

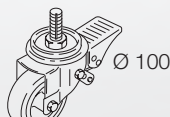

> **RG**

Roller conveyor
 Piani a rulli
 Rollenbahnen
 Plans à rouleaux
 Rodillos libres

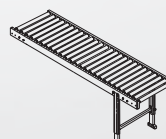

> **GTL - GTR**

Extendable conveyor
 Rulliera estensibile
 Ausziehbare rollenbahnen
 Convoyeur extensible
 Rodillos extensibles

